



*Hanover* / 305

hanoveryachts.com / 2024



**A sporty vessel with the power to conquer the sea at your will.**

The Hanover 305 could be your gateway to the boating world, affordable, luxurious, sporty and practical. With an Inboard powerful engine, you will not only generate speed but style, taking you, your friends and family to the best trips at sea, to relax or celebrate the best moments in life.

**YOUR BEST BOATING LIFE AWAITS**

---

*Hanover*

---



*Hanover* 305

2024



*Hanover 305*

2024



*Hanover* 305

2024

# TECHNICAL SPECIFICATIONS



**LENGTH**  
31' 11" / 9.75 m



**BEAM**  
9' / 2.75 m



**DRAFT**  
26" / 0.6 m



**DRY WEIGHT**  
6,305 lbs / 2,860 kg



**FUEL TANK CAPACITY**  
118 gal / 450 L



**WATER TANK CAPACITY**  
27 gal / 100 L



**HOLDING TANK**  
20 gal / 75 L



**CAPACITY**  
12 day / 4 Night



**CRUISING SPEED**  
28-30 mph / 45-48 kmh  
Range: 30mph - 14.5 gal/h



**WIDE OPEN THROTTLE**  
42-49 mph / 67-78 kmh  
Range: 42mph - 33.5 gal/h



**DEADRISE**  
18°



**BRIDGE CLEARANCE**  
8' 2" / 2.4m



*Hanover* 305

2024

## A CABIN

- 1 Acrylic access door with lock and key
- 2 Stainless steel staircase with 2 wide teak steps
- 3 Microwave space
- 4 Decorative mirror on the bow
- 5 U-shaped sofa for 3 people convertible into a double bed
- 6 Double bed amidships
- 7 Compartment under double bed
- 8 Basic layette kit with 2 pillows and 4 pillows

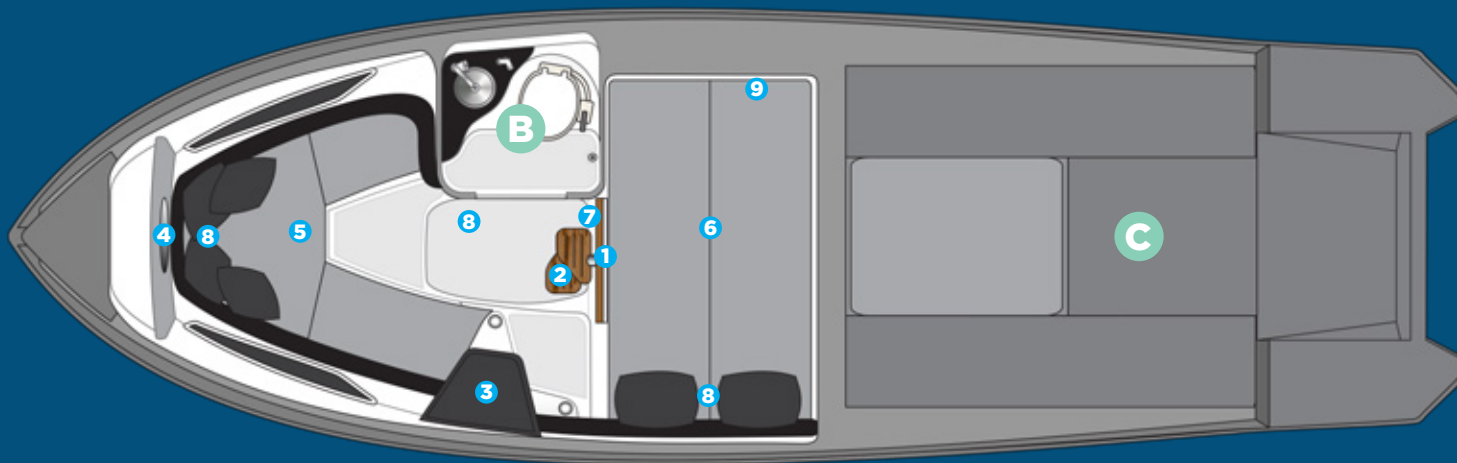

## B BATHROOM

- Electric toilet with 80 liter waste box, macerator pump and external nozzle
- Cabinet with one door, synthetic granite sink with stainless steel sink
- Air cabinet with mirrored door
- Non-slip floor
- Hygienic shower

## C ENGINE

- Gray gelcoat interior paint
- Non-slip flat floor
- Smoke sensor
- Fire extinguisher
- Sealed battery compartment
- Separate compartment for fuel tank
- Exhaust fan
- Quick access door with gas pistons

# HULL AND COCKPIT

- 1** 6 6" stainless steel cleats
- 2** Tall stainless steel rail with teak seat in the bow
- 3** Acrylic hatchway in the bow
- 4** Acrylic hatch
- 5** Instrument panel that supports up to two 9" electronics with built-in compass
- 6** Dual rider seat with leg rest for standing or sitting
- 7** Two sofas in the cockpit
- 8** Chaise on port
- 9** 2 Fixed panoramic windows in acrylic
- 10** 1 Tilting tempered glass window amidships
- 11** Teak table
- 12** Steps to the bow

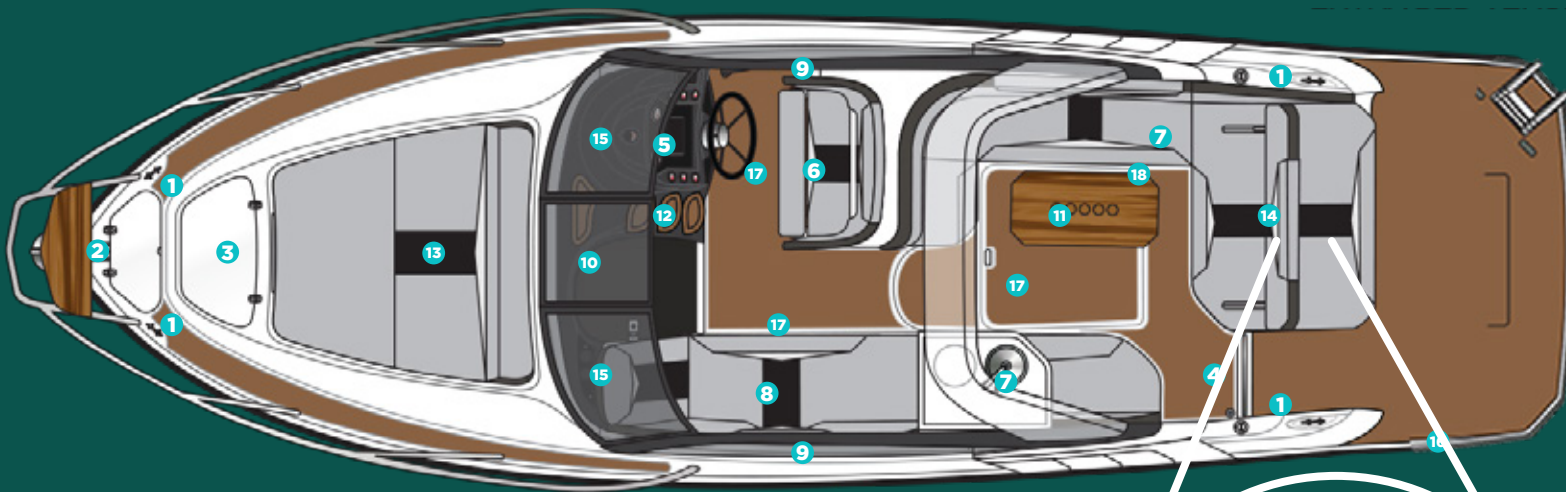

- 13** Bow solarium with headrest
- 14** Gourmet Area or Extra Bed
- 15** Tempered glass windshield and anodized aluminum frame
- 16** 3-Step telescopic ladder on platform
- 17** 3 Compartments below the cockpit seats
- 18** 1 Thermal compartment below the seat

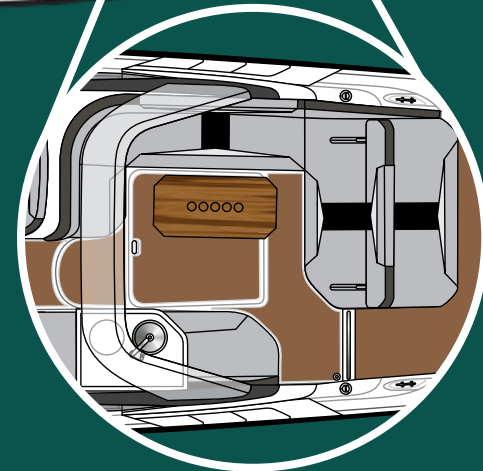

**EXTRA BED OPTIONAL LAYOUT**



# EXTRA BED OPTIONAL LAYOUT



An aerial, top-down view of a sleek speedboat moving across the ocean. The boat is dark-colored and has a white wake behind it. The water is a deep blue with some white foam from the wake. The text is centered over the boat's deck area.

**CUSTOMIZE AND  
HAVE THE MOST UNIQUE  
VESSEL AT SEA**



# EXTERIOR PAINT OPTIONS

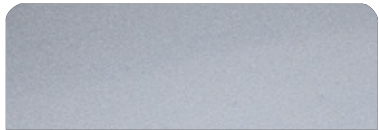

Grigio Silver

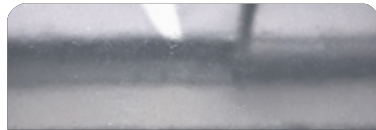

Tungsten Silver



Pure Gray

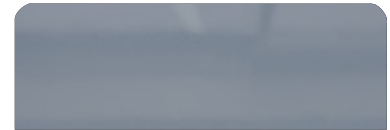

Nardo Gray

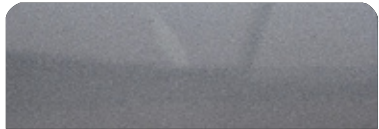

Orkney Gray (Highgloss)

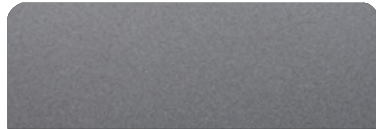

Orkney Gray (Matte)

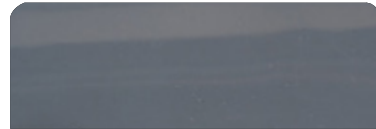

Moonstone Gray



Sequin Blue

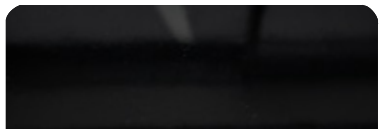

Gales Black (Tuxedo) (Highgloss)



Gales Black (Tuxedo) (Matte)

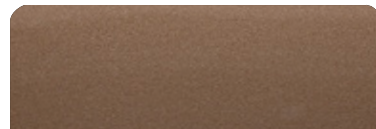

Havanna Brown



Heraldic Blue

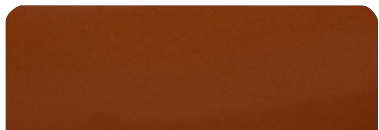

Orange Pearl



Moscou Red

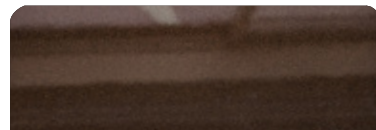

Marrakesh Brown



Macaw Blue



# UPHOLSTERY OPTIONS

## UPHOLSTERY DESIGN



Classic

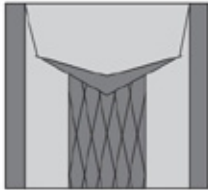

Diamond



Vintage

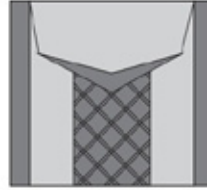

Elegant



Sporty

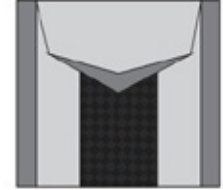

Carbon Fiber

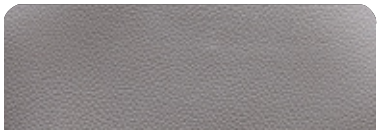

Fern

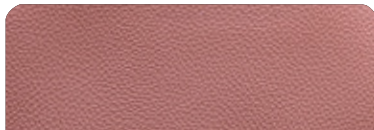

Terracota

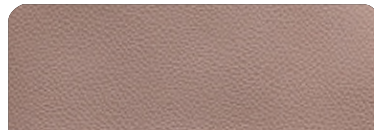

Caramello

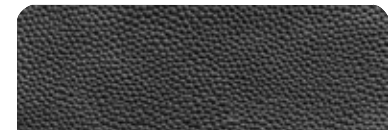

Black

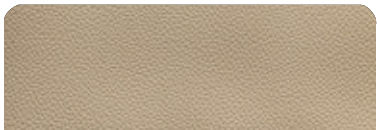

Land Rover



Taupe

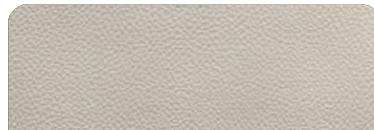

Ivory



Orange

# UPHOLSTERY OPTIONS



Off White



Gray

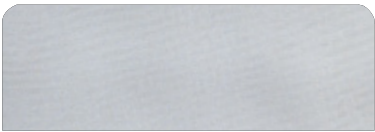

Silver



Carbon Fiber



White



Beige



Matelasse Honeycomb



New Corolla



Blue



Corolla

# FURNITURE VINYL OPTIONS



Salina

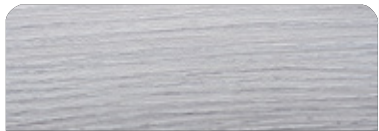

Alder

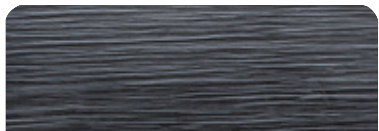

Black Line



Massal



Bronze

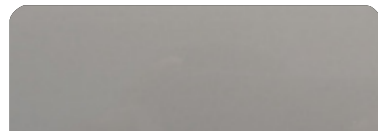

Taupe High Gloss

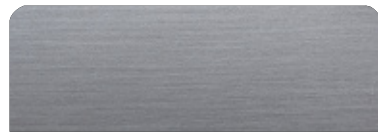

Metallic

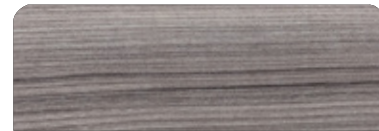

Cherry



Freije

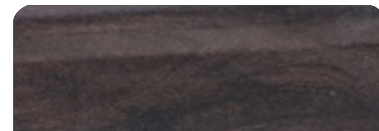

Canyon



Gray Oak



Patina

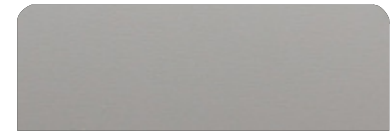

Taupe Super Matte

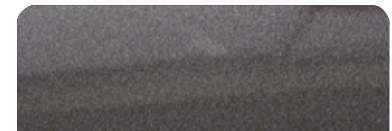

Onix

# DECK FLOORING OPTIONS

## PATTERNS

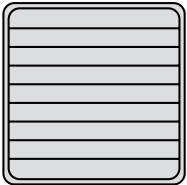

Classic

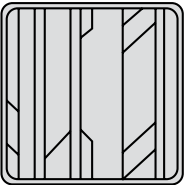

Aztec

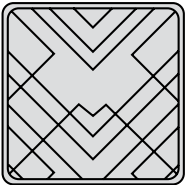

Imperial

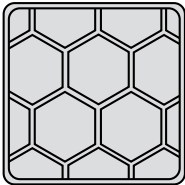

Beehive

## EVA



Tuscany



Ocher

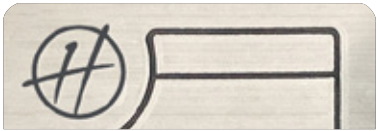

Gray

## SYNTHETIC TEAK



Gray



Madeira



Sand



# INTERIOR PAINT OPTIONS



Ivory Beige



Mist Beige



Corolla Gray



Black

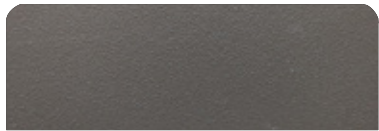

Terra Brown



White

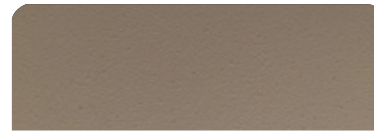

Land Rover



Compass Gray





# LUXURIOUS & SPORTY

---

Get the best of both worlds and make lifelong memories with the Luxurious and Sporty HANOVER 305.

As soon as you start handling the 305 you will know for certain that you've made one of the best decisions of your life.

*Hanover* 305

2024





Hanover 305



2024

# STANDARD EQUIPMENT

## HULL AND DECK

- 6 6" stainless steel cleats
- 1 looked in the bow
- 2 Eyes on the stern
- Tall stainless steel rail with teak seat in the bow
- Anchor support + stainless steel protection plate
- Stainless steel water, fuel and waste water nozzles
- Stainless steel vents, side outlets and manhole
- PVC brace with stainless steel finish
- Acrylic hatchway in the bow
- 2 stainless steel elliptical portholes
- 2 Fixed panoramic windows in acrylic
- 1 tilting tempered glass window amidships
- Tempered glass windshield and anodized aluminum frame
- 3-step telescopic ladder on platform
- Bow solarium with headrest
- Stainless steel grabs in the gourmet space
- 3 compartments below the cockpit seats
- 1 thermal compartment below the seat
- teak table
- Anti-mold nautical corvim upholstery
- Storage, acrylic
- Acrylic cup holders in the cockpit
- White isophthalic gelcoat paint
- Instrument panel that supports up to two 9" electronics with built-in compass
- Dual rider seat with leg rest for standing or sitting
- Two sofas in the cockpit
- Chaise on port
- Stainless steel balustrade at stern (outboard motors only)

## CABIN

- Acrylic access door with lock and key
- Stainless steel staircase with 2 wide teak steps
- Furniture in Ultra Moisture resistant MDF
- Microwave space
- 2 compartments under the seats
- Decorative mirror on the bow
- U-shaped sofa for 3 people convertible into a double bed
- Double bed amidships
- Waterproof fabric coverings or anti-mold nautical corvin
- Basic layette kit with 2 pillows and 4 cushions

## ENGINE ROOM

- Gray gelcoat interior paint
- Non-slip flat floor
- Smoke sensor
- Fire extinguisher
- Sealed battery compartment
- Separate compartment for fuel tank
- Exhaust fan
- Quick access door with gas pistons
- 316 liter aluminum fuel tank and level gauge

## PUMPS AND TANKS

- Drinking water tank with 27 Gallons and external supply
- 1.9 Gph booster pump
- 2 bilge pumps in the engine room with automatic
- 1 bilge pump amidships with automatic
- Aft shower
- Bathroom sink and gourmet area with stainless steel faucets

## HEAD

- Electric toilet with 80 liter waste box, macerator pump and external nozzle
- Cabinet with one door, synthetic granite sink with stainless steel sink
- Air cabinet with mirrored door
- Hygienic shower
- Non-slip floor

## ELECTRICAL

- Circuit breaker board
- Selector switch for pier/generator/inverter
- Electrical panel in the cockpit with special switches
- BB/BE navigation lights
- Anchoring mast with conjugated strobe
- Indirect LED lighting on the cabin ceiling and display cabinet
- 3 Courtesy lights in the cockpit
- LED spotlights on the bathroom and cabin ceiling
- LED spotlights on the targa
- Pier socket
- Individual master switches for accessory batteries and motors
- Automatic charging relay for batteries
- Emergency departure
- 1 150 Ah battery for accessories
- 2 150 Ah batteries for engines

## OPTIONS INCLUDED

- Synthetic Teak or EVA Flooring on Bow, Cockpit & Platform
- Stainless Steel Railing with Teak Seat on bow
- Sound System
- Anchor Windlass System - 800w + 7,5g Anchor and 40m Chain
- VHF radio w/ Antenna
- Macerator and Holding tank
- Electric boiler system in the toilet
- 12v / USB Sockets on Dashboard and in Cabin
- Electric trim tabs (flaps)
- Pier outlet
- Complete power inverter and charger system + internal ac (220v or 110v )
- Acrylic cup holders
- 2 stools (seats) at platform
- Wakeboard Mast
- Bow Sundeck
- Fenders & Lines
- USCG Boating Safety Kit
- Shore Power Cord

# ESSENTIAL PACKAGE

# PREMIUM PACKAGE

	<b>MERCURY® MERCUISER 300HP</b>	<b>MERCURY® MERCUISER 350HP</b>
Engine		
GPS	GPS SIMRAD® GO7 (7")	<b>GPS SIMRAD® GO9 (9")</b>
Sound System	BOSS® SOUND SYSTEM + 6 JBL® Marine Speakers + Amplifier	<b>FUSION® SOUND SYSTEM + 6 Marine Speakers + Amplifier</b>
Exterior Painting	1 Color (Hull)	<b>2 Colors or More (Hull, Deck or HT)</b>
Power Charger/Inverter 1800W	✓	✓
VHF Radio w/ Antenna	✓	✓
Synthetic Teak or EVA Flooring	✓	✓
Electric Toilet System	✓	✓
Anchor Windlass Electric System	✓	✓
Electric Trim Tabs (Flaps)	✓	✓
Fenders & Lines	✓	✓
USCG Boating Safety Kit	✓	✓
Shore Power + Shore Cord 30A	✓	✓
Macerator Pump and Holding Tank	✓	✓

Galvanic Isolator (Electrical Protection)	✓	✓
Internal Table (Cockpit)	✓	✓
Cradle for Transport	✓	✓
Exterior Sport Painting and Sport Seats		✓
Design Items Set (Pillows, Beddings, Cushions, Towels, Accessories)		✓
Folding System for Sunbeds (Bow)		✓
Bimini Top Cover		✓
USB Extra Socket		✓
Italian Steering Wheel		✓
Headlights w/ Remote (Cruising Spotlight)		✓
	<b>\$195,000</b>	<b>\$209,500</b>



# ADDITIONAL UPGRADES



Electric Fun Deck Platform

**\$13,500**



Hydraulic Underwater Swim Platform

**\$19,950**



MC<sup>2</sup> Quick Gyro X3 Stabilizers

**\$29,950**



A/C System (Battery Operated) (Mabru)

**\$15,900**



Boat Trailer

**\$9,950**



GPS Raymarine® Element 7s (7") (Additional Screen)

**\$2,250**



GPS Raymarine® AXIOM (9") (Additional Screen)

**\$4,950**



GPS Raymarine® AXIOM (12") (Additional Screen)

**\$7,950**



GPS Garmin® MAP 923xsv NMEA & Transducer (9") (Additional Screen)

**\$4,995**



GPS Garmin® MAP 1242xsv NMEA & Transducer (12") (Additional Screen)

**\$8,750**



GPS SIMRAD® Go7 (7") (Additional Screen)

**\$3,295**



GPS SIMRAD® Go9 (9") (Additional Screen)

**\$4,350**



Mercury® Vessel View (7") (Additional Screen)

**\$3,950**



Mercury® Vessel View (9") (Additional Screen)

**\$4,500**



Raymarine Radar Quantum I

**\$6,750**

# ADDITIONAL UPGRADES



Underwater Lights  
(Pair)

**\$1,500**



Fusion® Marine Amplifier  
(5 Channels) 1600W

**\$1,595**



Fusion® Marine  
Speakers (Extra Pair)

**\$895**



JBL® Marine Amplifier  
(Extra) (2 Channels)

**\$1,395**



JBL® Marine Speakers  
(Extra Pair)

**\$695**



Canvas Snap-On  
Boat Cover

**\$3,500**



Fiberglass  
T-Top

**\$7,950**



Stainless Steel  
T-Top

**\$8,350**

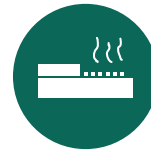

Kenyon Electric Grill (Stern)  
(Requires Generator)

**\$3,750**



Power Charger/  
Inverter 3000w

**\$1,950**



Coastal Flush Kit For  
Engines 250 And Under

**\$750**



Fireboy® - Advanced  
Automatic Anti-fire System

**\$9,500**



Waterproof Dashboard  
Cover (Helm)

**\$500**



Set of Waterproof  
Exterior Seat Covers

**\$2,500**



Complete Branded  
Boat Nylon Cover

**\$3,200**



# ADDITIONAL UPGRADES

---



LED TV Set  
And Mounting

**\$950**



Microwave

**\$750**



Hot Water  
System Boiler - Heater (Shower)

**\$4,200**



Eisenglass  
Enclosure

**\$3,200**



Bow  
Thrusters

**\$9,500**



Bottom Paint  
Anti-fouling Coppercoat Paint

**\$6,950**



Refrigerated 12V  
Drawer (Cockpit)

**\$2,950**

# PREMIUM UPGRADES

Got Essential but want more?  
Upgrade to our **Premium** options.



Mercury®  
Mercruiser 350HP

**\$5,000**



USB  
Extra Socket

**\$250**



GPS SIMRAD®  
Go9 (9")

**\$1,250**



Fusion® Marine Sound System Kit  
+ 6 Speakers + Amplifier

**\$2,450**



Head Lights W/ Remote  
(Cruising Spotlight)

**\$1,200**



Folding System For  
Sunbeds (Bow)

**\$500**



Italian Steering  
Wheel

**\$750**



Design Items Set  
(Pillows, Beddings, Cushions,  
Towels, Accessories)

**\$3,095**



Bimini Top  
Cover

**\$1,500**



External Double Painting  
(2 Or More Colors, Hull, Deck Or HT)

**\$1,500**



Exterior Sport Painting  
and Seats

**\$950**

# PREMIUM+ UPGRADES

Got **Premium** but want more?  
Upgrade to our **Premium+** options.



Mercury®  
Mercruiser 380HP

**\$8,975**



Mercury®  
Mercruiser 270HP Diesel

**\$19,950**



Mercury®  
Mercruiser 320HP Diesel

**\$26,950**



GPS SIMRAD®  
NSS12 (12")

**\$2,600**



GPS SIMRAD®  
NSO EVO3 (16")

**\$4,950**



Bimini Top Cover w/  
Stainless Steel  
Structure

**\$750**



Bimini Top  
w/ Full Enclosure

**\$1,950**



JL AUDIO KIT 1  
Media Master,  
6 Speakers, AMP

**\$2,050**



JL AUDIO KIT 2  
Media Master, 8 Speakers,  
Media Controller, AMP, SUB

**\$6,950**

# SHIPPING DIMENSIONS

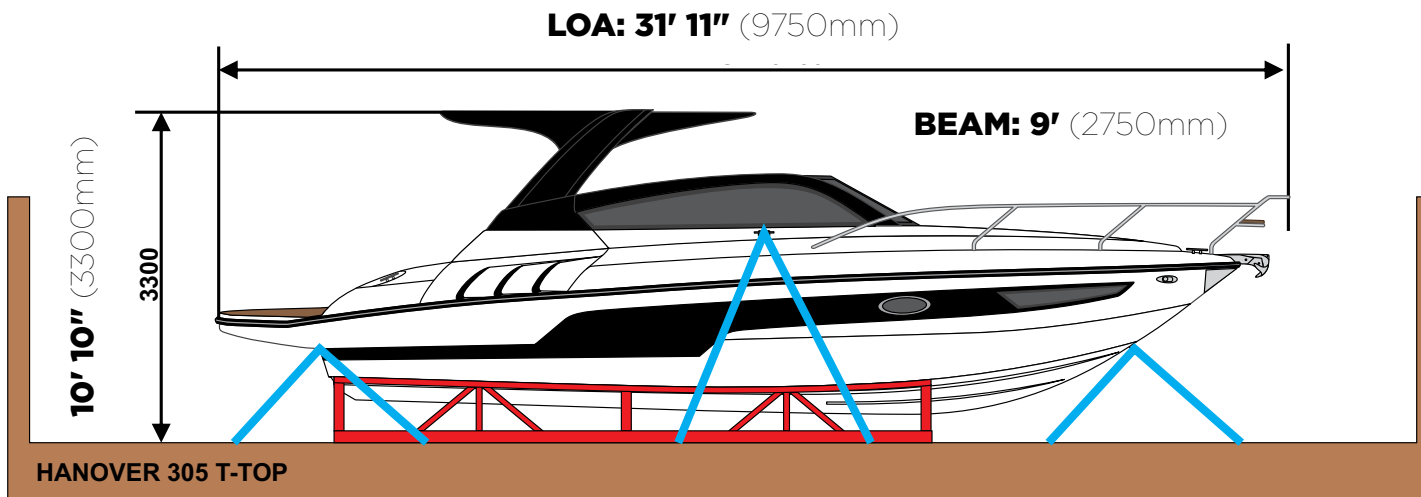
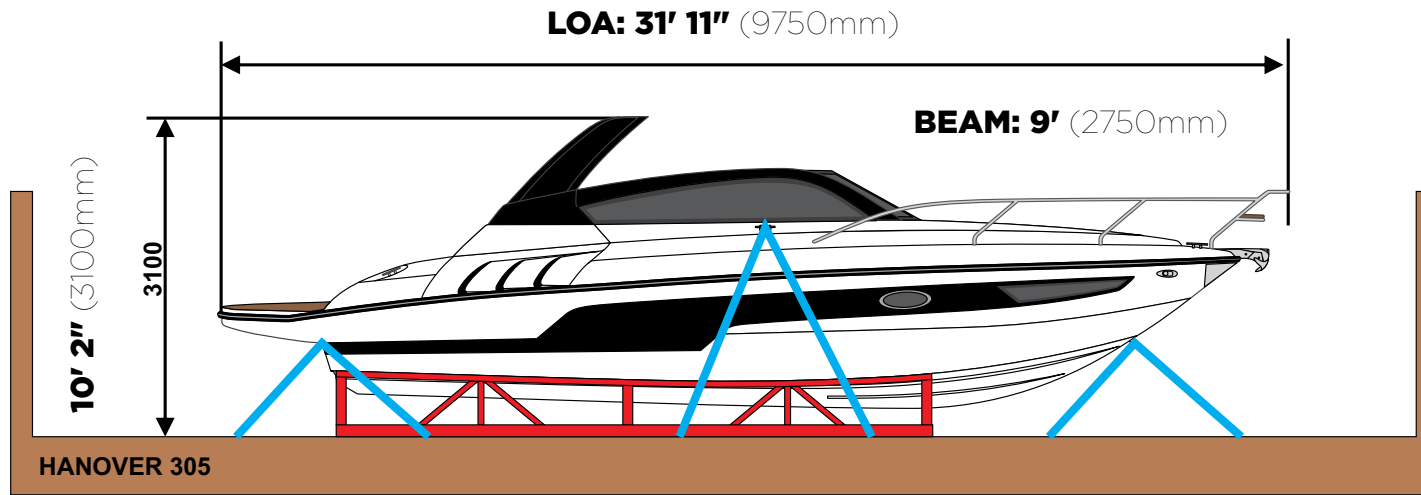

# HANOVER OWNERSHIP PROGRAM

---

At Hanover, we ensure an exciting stress-free experience from the moment you discover our brand.

## **STRESS-FREE PRICING**

Our entire lineup comes at our lowest price - no haggling needed. Leave the negotiations to used car salesmen, and enjoy a straightforward buying experience with us.

## **FIRST TRIP**

We've got you covered - you will get training and your first cruise comes with a captain by your side (up to 4 hours). Feel like a pro and make the most of your experience!

## **MAINTENANCE AND WARRANTY**

Every Hanover vessel includes a 5-Year Premier Level Hull Warranty, 1 Year General, Mechanical and Components Warranty, All Accessories & Electrical Parts Under The Original Manufacturer's Warranty.

Sail with complete confidence knowing you have a team of dedicated professionals at your service.

**Don't just own a boat, be part of the Hanover Lifestyle.**

*Hanover*

*Hanover*

[www.hanoveryachts.com](http://www.hanoveryachts.com)